

ROPL2M-MI-UNP6X-H1141

Fotoelektrik sensör – Retroreflective Sensor with Polarizing Filter

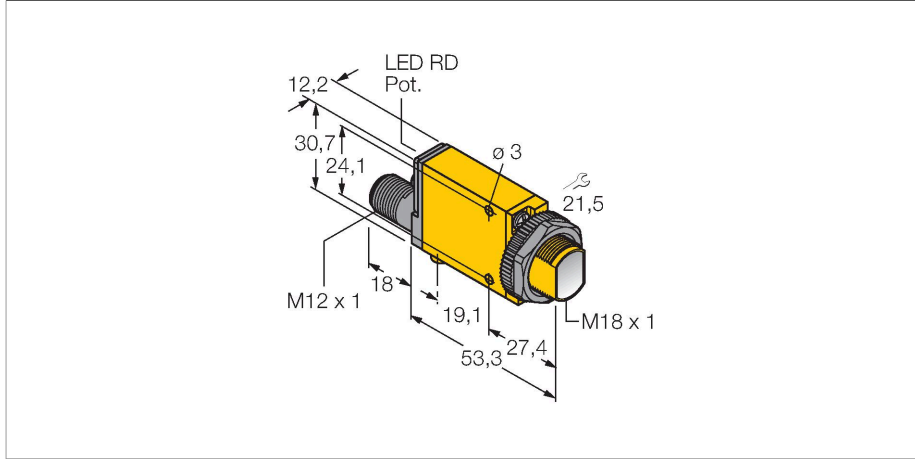

Özellikler

- Male, M12 x 1, 4-pin
- Protection class IP67
- Sensitivity adjusted via potentiometer
- Alignment indicator
- Operating voltage: 10...30 VDC
- Switching output, bipolar
- Light/dark operation

Kablo bağlantı şeması

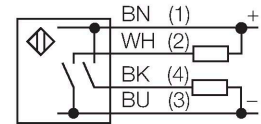

Teknik Veriler

Tip	ROPL2M-MI-UNP6X-H1141
Tanıt. no.	7700529
İşlev	polarizasyon filtreli reflektörlü sensör
Işık tipi	kırmızı
Dalga boyu	650 nm
Mesafe	0...3000 mm
Çalışma voltajı	10...30 VDC
Kaçak dalgalanma	< 10 % U _{ss}
DC nominal çalışma akımı	≤ 150 mA
Yük akımı yok	≤ 25 mA
Çıkış işlevi	NA kontak, PNP/NPN
Anahtarlama frekansı	≤ 500 Hz
Aşırı akımda serbest bırakma	> 220 mA
Tasarım	Dikdörtgen, Mini Beam
Boyutlar	71.3 x 12.3 x 30.7 mm
Gövde malzemesi	Plastik, PBT, Sarı
Lens	plastik, Acryl
Elektriksel bağlantı	Konektörler, M12 x 1
Ortam sıcaklığı	-20...+70 °C
IP Derecesi	IP67
Anahtarlama durumu	LED, kırmızı
Aşırı kazanç göstergesi	LED, kırmızı, yanıp sönüyor

İşlevsel prensip

Retroreflective sensors have emitter and receiver incorporated in the same housing. The light beam of the emitter is directed towards a reflector which returns the light back to the receiver. A target is captured when it interrupts this beam. Retroreflective sensors feature some of the advantages of opposed mode sensors, such as good contrast and high excess gain. Furthermore, only one device has to be installed and wired. Devices without polarizing filter have a smaller sensing range and are more susceptible to disturbances caused by shiny objects.

Excess gain curve
Excess gain in relation to distance

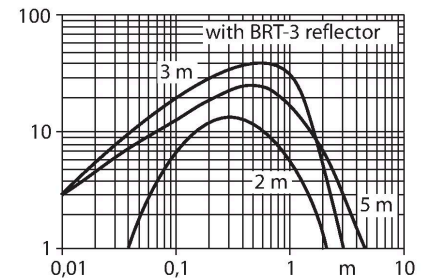

Aksesuarlar

TMBM18FA

7700395

Mounting bracket; material VA 1.4401, for 18 mm thread

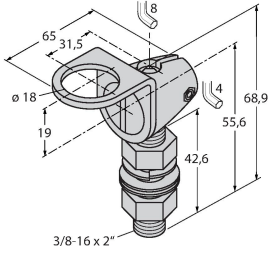

TMB18SF

7700396

Mounting bracket, PBT black, for 10 mm thread

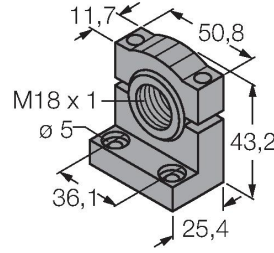

TMB3018SC

7700397

Mounting bracket, PBT black, for 18 mm thread

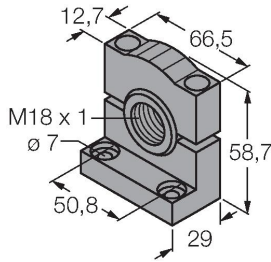

TMBMIS

7700401

Mounting bracket, stainless steel, for BT18/BQ18 and ..-MI-..

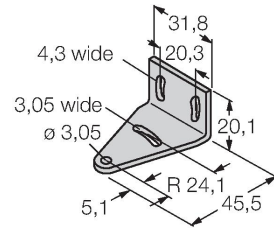

Aksesuarlar

Ölçekli çizim

Tip

Tanit. no.

T-BRT-3

7700369

Round reflector, reflection coefficient 1.0, material acrylic, ambient temperature -20 ... +60 °C

