

LOP3.5M-BT18-VN6X2-H1141

Fotoelektrik sensör – Retroreflective Sensor with Polarizing Filter

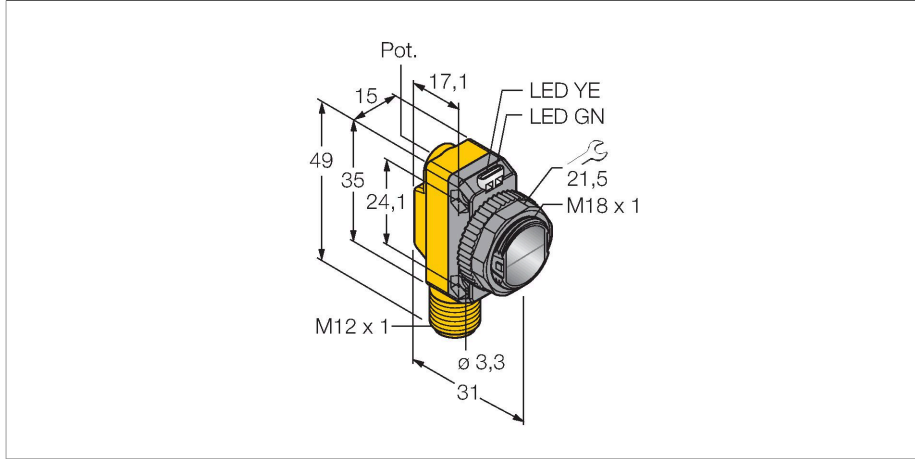

Teknik Veriler

Tip	LOP3.5M-BT18-VN6X2-H1141
Tanıt. no.	7700663
İşlev	polarizasyon filtreli reflektörlü sensör
Işık tipi	kırmızı
Dalga boyu	660 nm
Mesafe	50...3500 mm
Çalışma voltajı	10...30 VDC
Kaçak dalgalanma	< 10 % U _{ss}
DC nominal çalışma akımı	≤ 100 mA
Kısa devre koruması	evet
Ters kutup koruması	evet
Çıkış işlevi	NA/NK kontağı, NPN
Akım çıkışı	100 mA
Anahtarlama frekansı	≤ 800 Hz
Tasarım	Dikdörtgen, QS18
Boyutlar	31 x 15 x 35 mm
Gövde malzemesi	Plastik, ABS
Lens	plastik, Acryl
Elektriksel bağlantı	Konektörler, M12 x 1
Ortam sıcaklığı	-20...+70 °C
IP Derecesi	IP67
Güç-açık göstergesi	LED, yeşil
Anahtarlama durumu	LED, sarı
Error indication	LED, yeşil, flashing
Aşırı kazanç göstergesi	LED, sarı, yanıp sönüyor

Özellikler

- Male, M12 x 1, 4-pin
- Protection class IP67
- LED, all-round visible
- Sensitivity adjusted via potentiometer
- Operating voltage: 10...30 VDC
- NPN switching output, changeover

Kablo bağlantı şeması

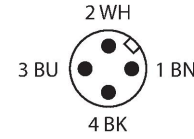
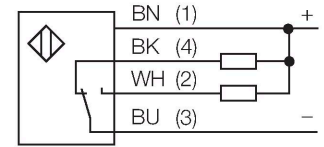

İşlevsel prensip

Retroreflective sensors have emitter and receiver incorporated in the same housing. The light beam of the emitter is directed towards a reflector which returns the light back to the receiver. A target is captured when it interrupts this beam. Retroreflective sensors feature some of the advantages of opposed mode sensors, such as good contrast and high excess gain. Furthermore, only one device has to be installed and wired. Devices without polarizing filter have a smaller sensing range and are more susceptible to disturbances caused by shiny objects.

Excess gain curve
Excess gain in relation to the distance (polarized)

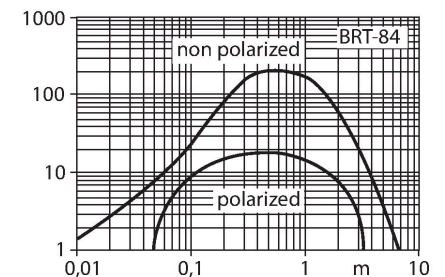

Aksesuarlar

TMBM18FA

7700395

Mounting bracket; material VA 1.4401, for 18 mm thread

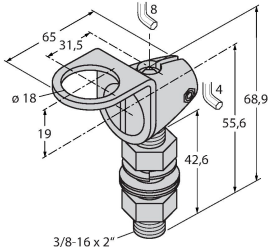

TMB18SF

7700396

Mounting bracket, PBT black, for 10 mm thread

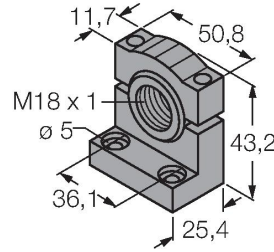

TMB3018SC

7700397

Mounting bracket, PBT black, for 18 mm thread

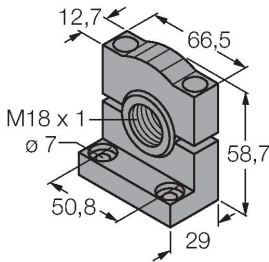

TMBMIS

7700401

Mounting bracket, stainless steel, for BT18/BQ18 and ..-MI-..

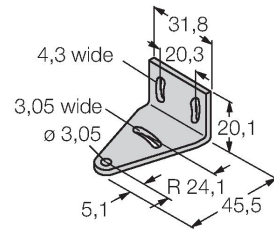

TMBBT18Y

7700425

Protective housing, stainless steel, for BQ18

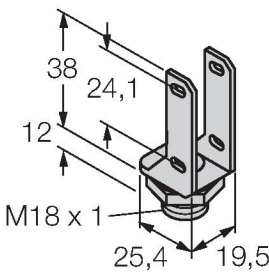

Aksesuarlar

Ölçekli çizim

Tip

Tanıt. no.

T-BRT-84

7700382

Round reflector, reflection coefficient 1.4, material acrylic, ambient temperature -20 ... +60 °C

